

Article number: 2310305525ESD

Description: E+G Antistatic base for levelling elements
LV.A-100-24-M16x98-ESD-C

Measures

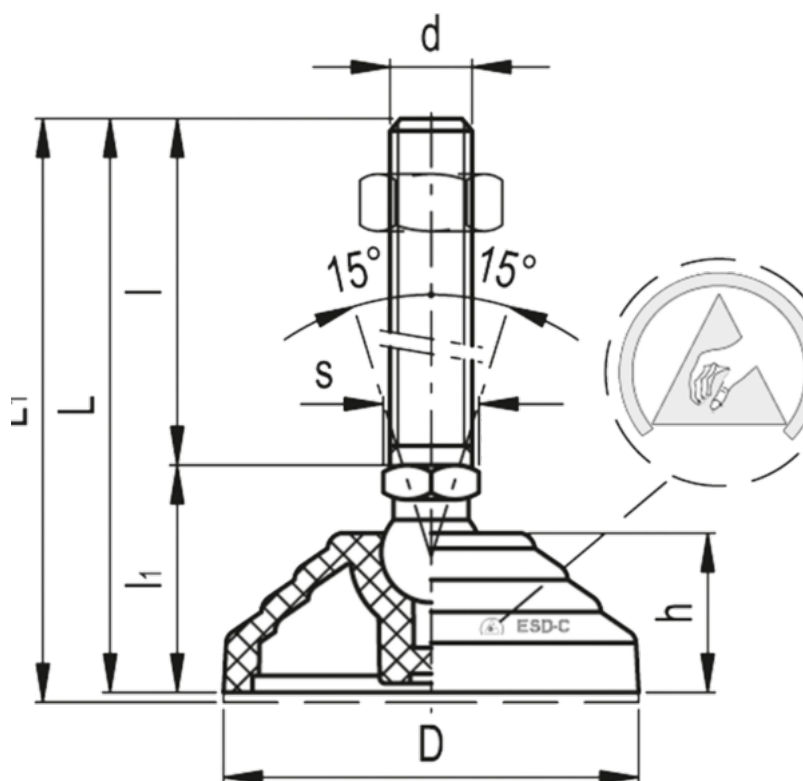

Articulation = 24
D = 100
d = M16
h = 24
l = -
l1 = -
L = 141
Max load = 25000

s = 24
Weight in (g) = 302